

Project Identity

Breeze

X326



C326

NATUZZI
EDITIONS

Project Identity

Breeze



C326 p. 3-17



X326 p. 18-28

Project Identity **Breeze**

C326



NATUZZI
EDITIONS

Project Identity

Natuzzi Editions

The Project Identity purpose is to offer a unique working method that guarantees chromatic and stylistic conformity and preserves the Brand's DNA.

This tool represents a guide that goes beyond the offer of a product, aiming at the creation of a real project from the stores to the customers' homes.

Breeze

Light as a summer breeze, welcoming as a hug, the Breeze sofa is designed for those seeking the perfect balance between elegance and relaxation. A true journey toward well-being, it invites you to surrender to its soft, fluid lines and high back, which gently envelop the body, offering a serene escape from the everyday. Let yourself be carried away by the lightness of the moment, where every detail is crafted for your comfort. The power motion technology allows you to effortlessly glide into your ideal relaxing position, while the adjustable headrest offers perfect support for your head. The journey doesn't stop there— the built-in USB charging port ensures that you can stay connected to your world, all while basking in the ultimate peace and tranquility.



Embrace a new philosophy of Comfort.
Feelwell combines physical relaxation
and mental balance, offering a tailor-made
wellness experience.



Design by Natuzzi Design Center

In the Natuzzi Headquarter in Puglia, the Design Center preserves the balance between design and functionality, values rooted in the brand's DNA.



Choose your Breeze

The Breeze project is extremely versatile thanks to its 13 components, available in 2 feet options, metal and wooden. Each combination allows us to create unlimited configurations. Here are some examples.

METAL FEET OPTION

WOODEN FEET OPTION

Sofa

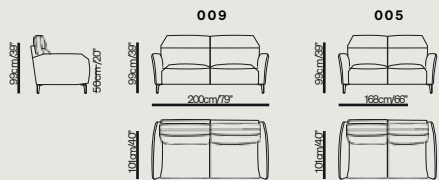

Armchair



Chair with arm

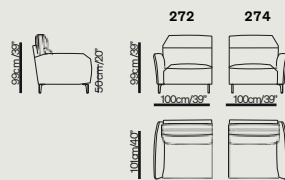

Sofa

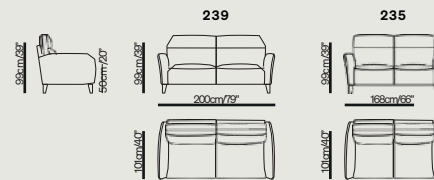

Armchair



Chair with arm

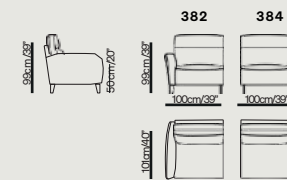

Power motion sofa

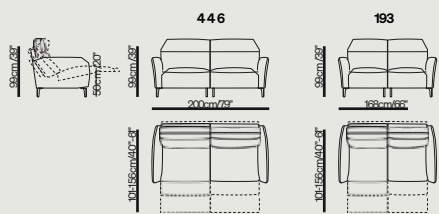

Power motion armchair



Armless chair

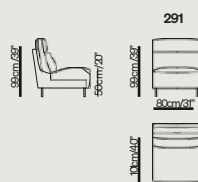

Power motion sofa

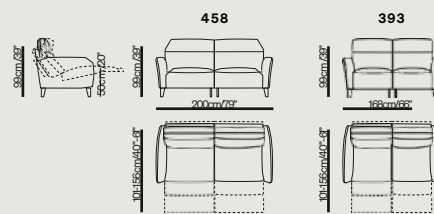

Power motion armchair



Armless chair



Power motion chair with arm

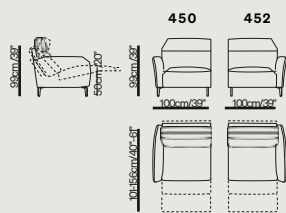

Power motion armless chair

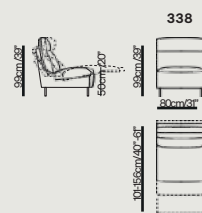

Square corner

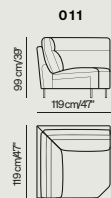

Power motion chair with arm

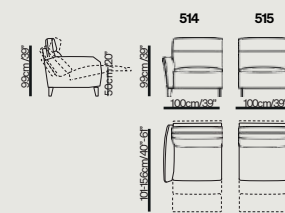

Power motion armless chair

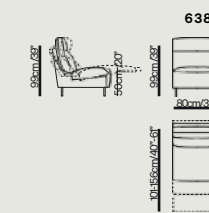

Square corner

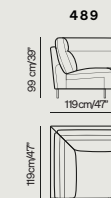

Optional battery pack

830



Versatility and configurations

The abacus «Versions and Compositions» shows all the versatility of the project. In particular, as in the examples below:



154*



446*

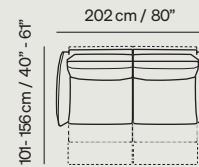

272+291+452*

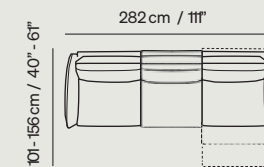

272+011+291+452*

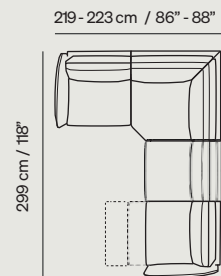

272+291+011+291+452*

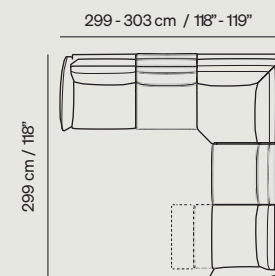

*The configuration examples are shown with metal leg option.

Features & Benefits



Power motion mechanism



Manually adjustable headrest (on power reclining versions)



USB Port



Multiple configurations



Available in Leather and Fabric



Customizable foot finishings



Optional battery pack available



Power Motion Mechanism

This power mechanism operates a smooth system enabling the seat, backrest, and footrest to fully recline, ensuring optimal comfort.



Manual adjustable headrest

The headrest inclination can be adjusted to offer ideal head support, especially useful when reading or viewing television.



Switch Panel Pocket

A fully upholstered pocket housing the switch panel enhances the visual appeal of the model, offering a distinctive aesthetic element. The switch panel is equipped with **USB Port** to comfortably charge your devices.



Optional metal or wooden leg

Metal legs available in silver (FT89) and matte black (FT79) finishing.

Wooden legs in wengè (FT18) and walnut (FT09) finishing.

Here shown on the left is the wooden leg option.

Layout examples

It's possible to highlight the versatility of the project even with different layouts, suggesting the creation of various roomsets to show the optimization of spaces in any living area.

DIM: 11 sqm / 118 sq ft

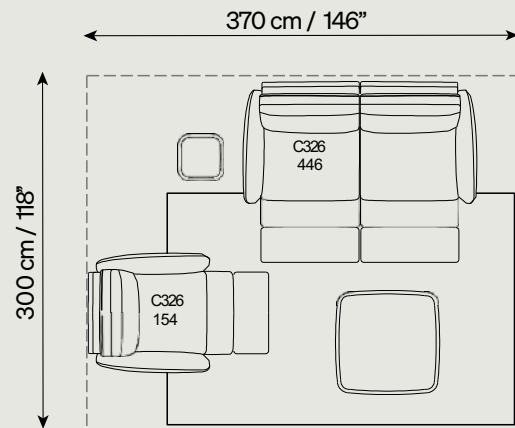

DIM: 12,5 sqm / 135 sq ft

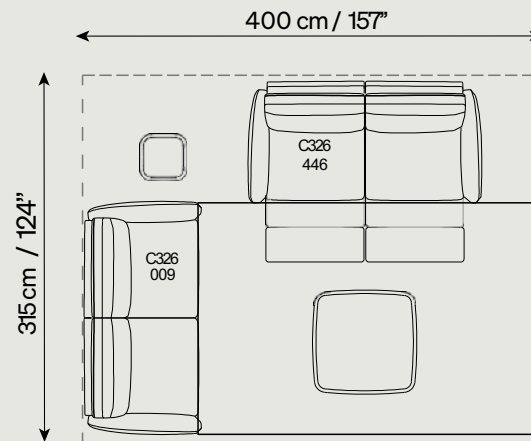

DIM: 13 sqm / 140 sq ft

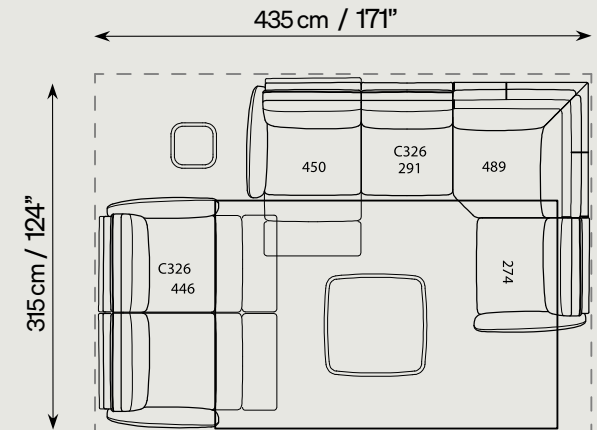

Moodboard blue

The Natuzzi Style Center carefully selects materials and coverings, putting them in dialogue with each other. In this case, the Dream leather in the Ocean color was paired with the Afrodite fabric in the Teal color. The combination of these coverings together with the wood & ceramic, will give rise to the moodboard that will create the final total look of the project. Each model in the collection is presented with multiple moodboards to adapt to homes all over the world.



Moodboard blue

Together with the moodboard of coverings and materials, the Style Centre harmonizes the sofa with furniture and accessories to complete the interior design project.

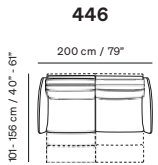

Sofa: Breeze C326
Feet Finish: FT 89 Silver



20JX DREAM

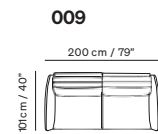

Sofa: Breeze C326
Feet Finish: FT 89 Silver



ITACA
78.0192.02

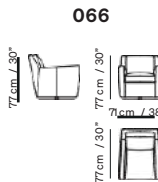

Occasional Chair: Inside C245
with swivel base



AFRODITE
78.0180.14

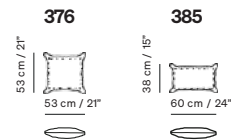

Pillow: A800



AFRODITE 78.0180.14
ITACA 78.0192.02



Central Table: Plettro
100cm/39" X 100cm/39" H35cm/14"
Ceramic Royal Peacock/Ash Brown
E22261X



Side Table: Plettro
D80cm/31" H47cm/18"
Ash Brown
E22262X



Table Lamp: Bag
35cm/14" X 32cm/12" H21cm/8"
White
L039007EOF

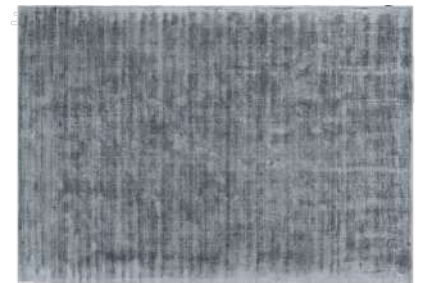

Rug: Whisper
300cm/118" X 400cm/157"
Light Ottanio
V823031XOF

These products have been carefully selected to maintain the atmosphere of the design. Therefore, while the sofa configurations can be changed to fit the space and personal needs, the combination of colors, materials and finishes cannot be altered.

Moodboard warm neutral

The Natuzzi Style Center carefully selects materials and coverings, putting them in dialogue with each other. In this case, the Le Mans leather in the Light Greige color was paired with the Marte fabric in the Beige Melange color. The combination of these coverings together with the wood, will give rise to the moodboard that will create the final total look of the project. Each model in the collection is presented with multiple moodboards to adapt to homes all over the world.



Moodboard warm neutral

Together with the moodboard of coverings and materials, the Style Centre harmonizes the sofa with furniture and accessories to complete the interior design project.

446

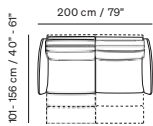

Sofa: Breeze C326
Feet Finish: FT 89 Silver

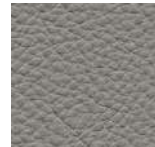

15C3 LEMANS

009

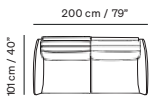

Sofa: Breeze C326
Feet Finish: FT 89 Silver



MARTE
78.0185.06

154

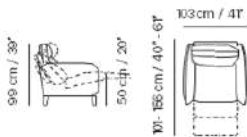

Recliner Chair: Breeze C326
Feet Finish: FT 89 Silver

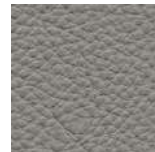

15C3 LEMANS

376

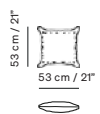

385

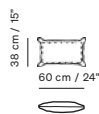

Pillow: A800



BREZZA
70.0077.21



Central Table: Gate
120cm/47\"/>



Rug: Patina
200cm/79\"/>

These products have been carefully selected to maintain the atmosphere of the design. Therefore, while the sofa configurations can be changed to fit the space and personal needs, the combination of colors, materials and finishes cannot be altered.

Moodboard warm neutral

The Natuzzi Style Center carefully selects materials and coverings, putting them in dialogue with each other. In this case, the Le Mans leather in the Light Beige color was paired with the Itaca fabric in the Beige color. The combination of these coverings together with the wood & ceramic, will give rise to the moodboard that will create the final total look of the project. Each model in the collection is presented with multiple moodboards to adapt to homes all over the world.



Moodboard warm neutral

Together with the moodboard of coverings and materials, the Style Centre harmonizes the sofa with furniture and accessories to complete the interior design project.

446

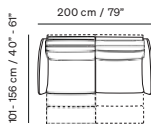

Sofa: Breeze C326
Feet Finish: FT 89 Silver



15C4 LE MANS

514-638-489-381-515

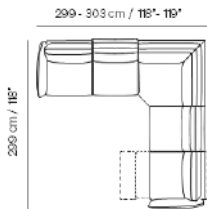

Sofa Sectional: Breeze C326
Feet Finish: FT 09 Walnut



ITACA
78.0192.01

154

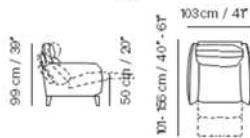

Recliner Chair: Breeze C245
Feet Finish: FT 89 Silver



15C4 LE MANS

376

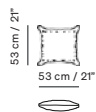

Pillow: A800

385

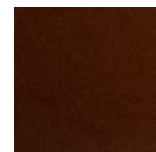
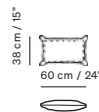

BREZZA
70.0077.23



Central Table: Gate
120cm/47" x 80cm/31" h38cm/15"
Ash Arena/Havana
Q186005XOF



Rug: Snorkeling
D240 cm/D94,5"
Earth Orange/Brown
V171002XOF



Cushion: Luxor
45cm/17" X 45cm/17" Pearl/Buttercup Orange
O926007XOF



Cushion: Luxor
45cm/17" x 33cm/13" Pearl/Orange
O926014XOF



Floor Lamp:
Virginia Brass
N096005UOF
(Available For U.S. Market)



Objects:
Log Vase S 18cm/7,1" x 15,5cm/6" H21cm/8,3" Gold Glazed
O976001XOF
LOG VASE M 14cm/5,5" x 11,5cm/4,5" H26cm/10,2" Gold Glazed
O976002XOF

These products have been carefully selected to maintain the atmosphere of the design. Therefore, while the sofa configurations can be changed to fit the space and personal needs, the combination of colors, materials and finishes cannot be altered.

Moodboard warm neutral

The Natuzzi Style Center carefully selects materials and coverings, putting them in dialogue with each other. In this case, the Le Mans leather in the Snow color was paired with the Marte fabric in the Beige Melange color. The combination of these coverings together with the wood, will give rise to the moodboard that will create the final total look of the project. Each model in the collection is presented with multiple moodboards to adapt to homes all over the world.



Moodboard warm neutral

Together with the moodboard of coverings and materials, the Style Centre harmonizes the sofa with furniture and accessories to complete the interior design project.

272+291+452

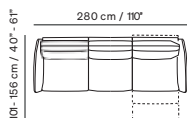

Sofa sectional: Breeze C326
Feet Finish: FT 89 Silver

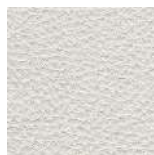

ECILE MANS

F45

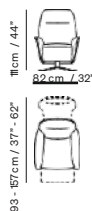

Power Recliner: Sidney C258
with swivel base



MARTE
78018506

376

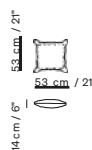

Pillow: A800

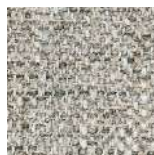

MARTE
78018505

385

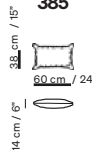

Pillow: A800



BREZZA
70007716



Central Table: Champignon
90cm/35" x 90cm/35" x H38cm/15"
Walnut/Glossy Black Metal
Q085001XOF
(available for China market)



Accent Table: Champignon
40cm/16" x 40cm/16" x H50cm/20"
Walnut/Glossy Black Metal
Q085003XOF
(available for China market)



Rug: Whisper
300cm/118" X 250cm/98"
Taupe
V823038XOF

These products have been carefully selected to maintain the atmosphere of the design. Therefore, while the sofa configurations can be changed to fit the space and personal needs, the combination of colors, materials and finishes cannot be altered.

Project Identity **Breeze**

X326



NATUZZI
EDITIONS

Project Identity

Natuzzi Editions

The Project Identity purpose is to offer a unique working method that guarantees chromatic and stylistic conformity and preserves the Brand's DNA.

This tool represents a guide that goes beyond the offer of a product, aiming at the creation of a real project from the stores to the customers' homes.

Breeze

Light as a summer breeze, welcoming as a hug, the Breeze sofa is designed for those seeking the perfect balance between elegance and relaxation. A true journey toward well-being, it invites you to surrender to its soft, fluid lines and high back, which gently envelop the body, offering a serene escape from the everyday. Let yourself be carried away by the lightness of the moment, where every detail is crafted for your comfort. The power motion technology allows you to effortlessly glide into your ideal relaxing position, while the adjustable headrest offers perfect support for your head. The journey doesn't stop there— the built-in USB charging port ensures that you can stay connected to your world, all while basking in the ultimate peace and tranquility.



Embrace a new philosophy of Comfort.
Feelwell combines physical relaxation
and mental balance, offering a tailor-made
wellness experience.



Design by Natuzzi Design Center

In the Natuzzi Headquarter in Puglia, the Design Center preserves the balance between design and functionality, values rooted in the brand's DNA.



Choose your Breeze

The Breeze project is extremely versatile thanks to its 13 components, available in 2 feet options, metal and wooden. Each combination allows us to create unlimited configurations. Here are some examples.

METAL FEET OPTION

WOODEN FEET OPTION

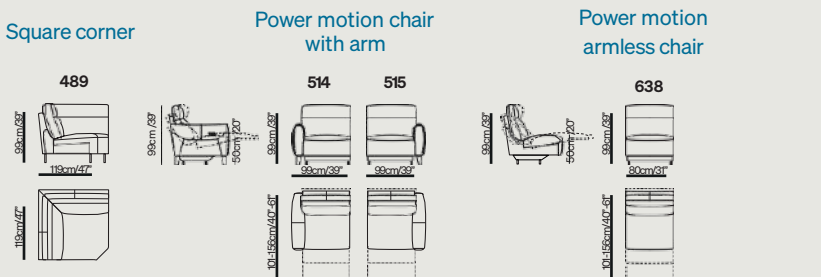
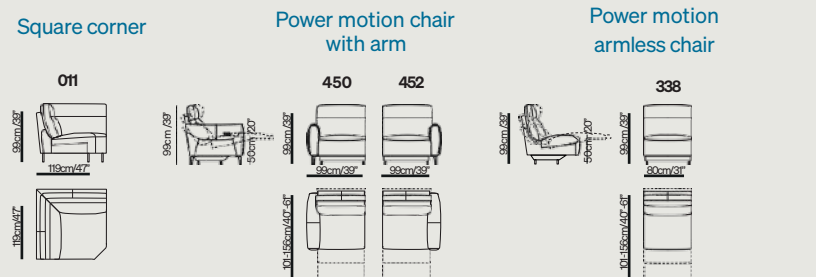
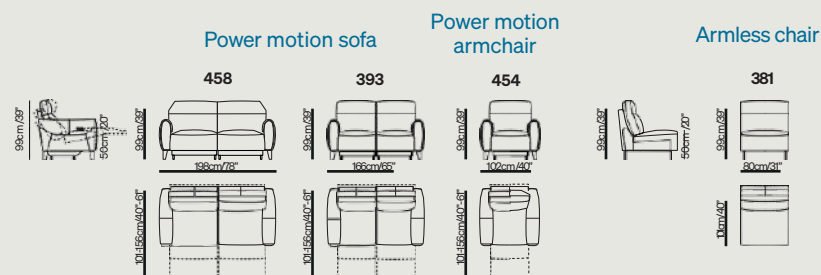
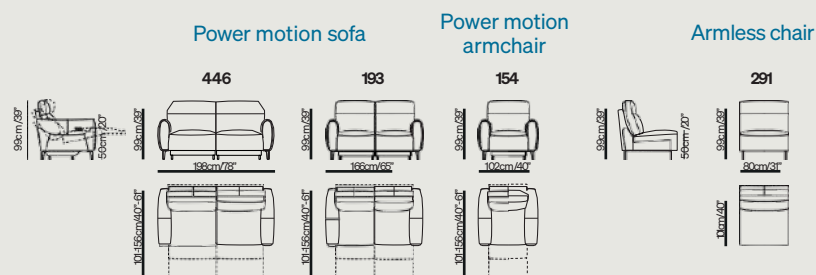
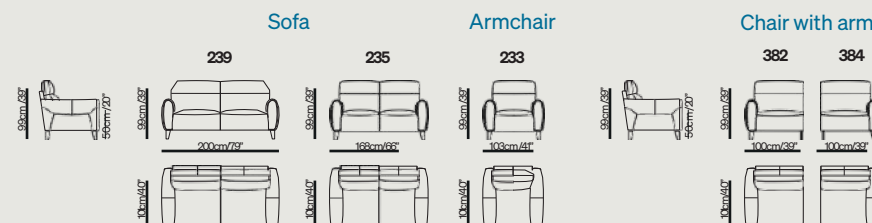
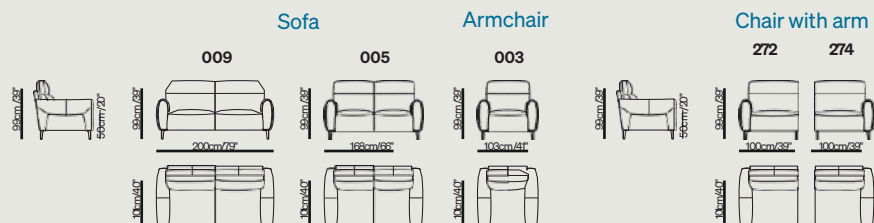

Optional battery pack



Versatility and configurations

The abacus «Versions and Compositions» shows all the versatility of the project. In particular, as in the examples below:



154 *

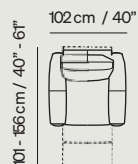

446 *

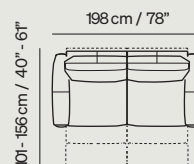

272+291+452 *

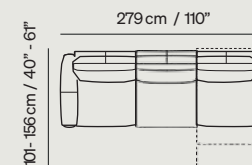

272+011+291+452 *

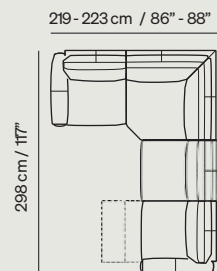

272+291+011+291+452 *

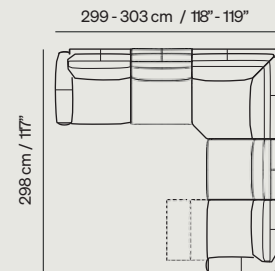

*The configuration examples are shown with metal leg option.

Thanks to the Configurator, it's possible to customize this versatility according to the customer's needs.

Features & Benefits



Power motion mechanism



Manually adjustable headrest (on power reclining versions)



USB Port



Multiple configurations



Available in Leather and Fabric



Customizable foot finishings



Optional battery pack available



Power Motion Mechanism

This power mechanism operates a smooth system enabling the seat, backrest, and footrest to fully recline, ensuring optimal comfort.

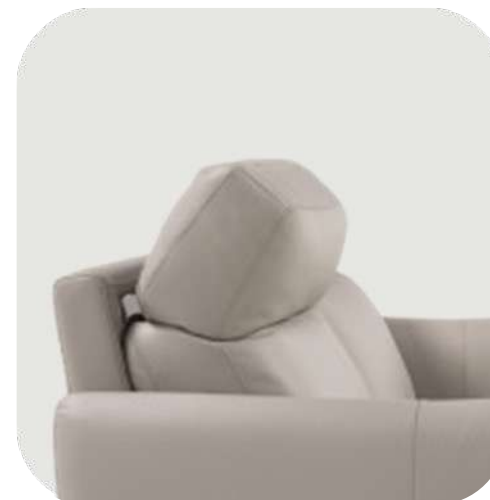

Manual adjustable headrest

The headrest inclination can be adjusted to offer ideal head support, especially useful when reading or watching television.



USB Port

the switch panel features a USB port to comfortably charge your devices.



Optional metal or wooden leg

Metal legs available in silver FT89) and matte black (FT79) finishing.

Wooden legs in wengè (FT18) and walnut (FT09) finishing.

Here shown on the left is the wooden leg option.

Layout examples

It's possible to highlight the versatility of the project even with different layouts, suggesting the creation of various roomsets to show the optimization of spaces in any living area.

DIM: 10,5 sqm / 113 sq ft

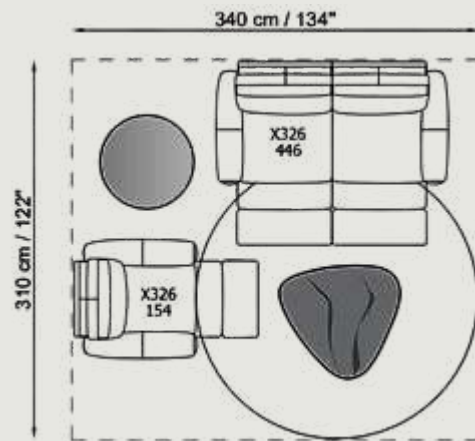

DIM: 12 sqm / 130 sq ft

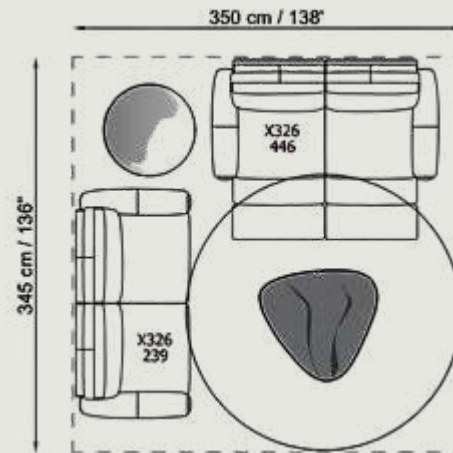

DIM: 15 sqm / 161 sq ft

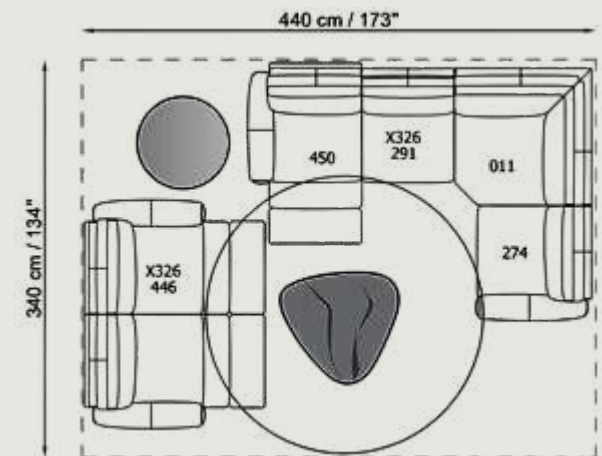

Moodboard warm neutral

The Natuzzi Style Center carefully selects materials and coverings, putting them in dialogue with each other. In this case, the Le Mans leather in the Light Beige color was paired with the Itaca fabric in the Beige color. The combination of these coverings together with the wood & ceramic, will give rise to the moodboard that will create the final total look of the project. Each model in the collection is presented with multiple moodboards to adapt to homes all over the world.



Moodboard warm neutral

Together with the moodboard of coverings and materials, the Style Centre harmonizes the sofa with furniture and accessories to complete the interior design project.

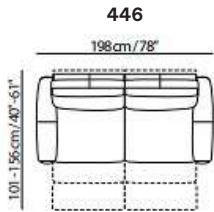

Sofa: Breeze X326 Feet
Finish: FT 89 Silver



15C4 LE MANS

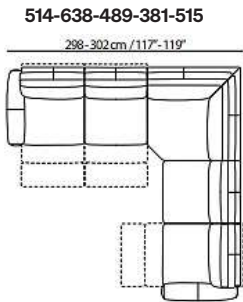

Sofa Sectional: Breeze X326
Feet Finish: FT 09 Walnut



ITACA
78.0192.01

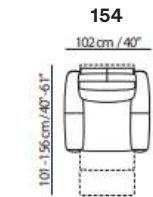

Recliner Chair: Breeze X245
Feet Finish: FT 89 Silver



15C4 LE MANS

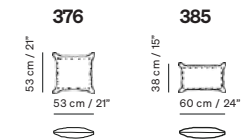

Pillow: A800

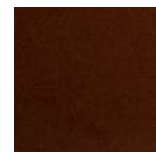

BREZZA
70.0077.23



Central Table: Gate
120cm/47" x 80cm/31" h38cm/15"
Ash Arena/Havana
Q186005XOF



Rug: Snorkeling
D240 cm/D94,5"
Earth Orange/Brown
V171002XOF



Cushion: Luxor
45cm/17" X 45cm/17" Pearl/Buttercup Orange
O926007XOF



Cushion: Luxor
45cm/17" x 33cm/13" Pearl/Orange
O926014XOF



Floor Lamp:
Virginia Brass
N096005UOF
(Available For U.S. Market)



Objects:
Log Vase S 18cm/7,1" x 15,5cm/6" H21cm/8,3" Gold Glazed
O976001XOF
LOG VASE M 14cm/5,5" x 11,5cm/4,5" H26cm/10,2" Gold Glazed
O976002XOF

These products have been carefully selected to maintain the atmosphere of the design. Therefore, while the sofa configurations can be changed to fit the space and personal needs, the combination of colors, materials and finishes cannot be altered.

Moodboard Cold neutral

The Natuzzi Style Center carefully selects materials and coverings, putting them in dialogue with each other. In this case, the Le Mans leather in the Platinum color was paired with the Afrodite velvet in the Taupe color. The combination of these coverings together with the marble & wood, will give rise to the moodboard that will create the final total look of the project. Each model in the collection is presented with multiple moodboards to adapt to homes all over the world.



Moodboard Cold neutral

Together with the moodboard of coverings and materials, the Style Centre harmonizes the sofa with furniture and accessories to complete the interior design project.

272-291-452

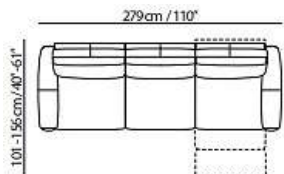

Sofa : Breeze X326
Feet Finish: FT 79 Matt Black



15F8 LE MANS



Central Table: Incontro
140cm/55" x 75cm/29" H38cm/15"
Brushed Brass/Ash Brown/Lilac Marble
T864011XOF
(AVAILABLE FOR CHINA MARKET)



Side Table: Incontro
65cm/25" x 65cm/25" H43cm/17"
Brushed Brass/Ash Brown/Lilac Marble
T864010XOF
(AVAILABLE FOR CHINA MARKET)

066

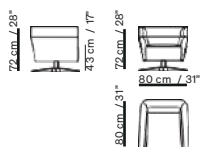

Occasional Chair: Spiritosa C117
Feet Finish: FT 78



78.0180.11
AFRODITE

106

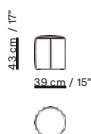

Ottoman: Gaia A921

615



78.0185.05
MARTE

376



Pillow: A800



78.0185.05
MARTE



Rug: Whisper
250cm/98" x 300cm/118"
Steel Grey
V823034XOF

These products have been carefully selected to maintain the atmosphere of the design. Therefore, while the sofa configurations can be changed to fit the space and personal needs, the combination of colors, materials and finishes cannot be altered.

NATUZZI
EDITIONS